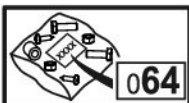
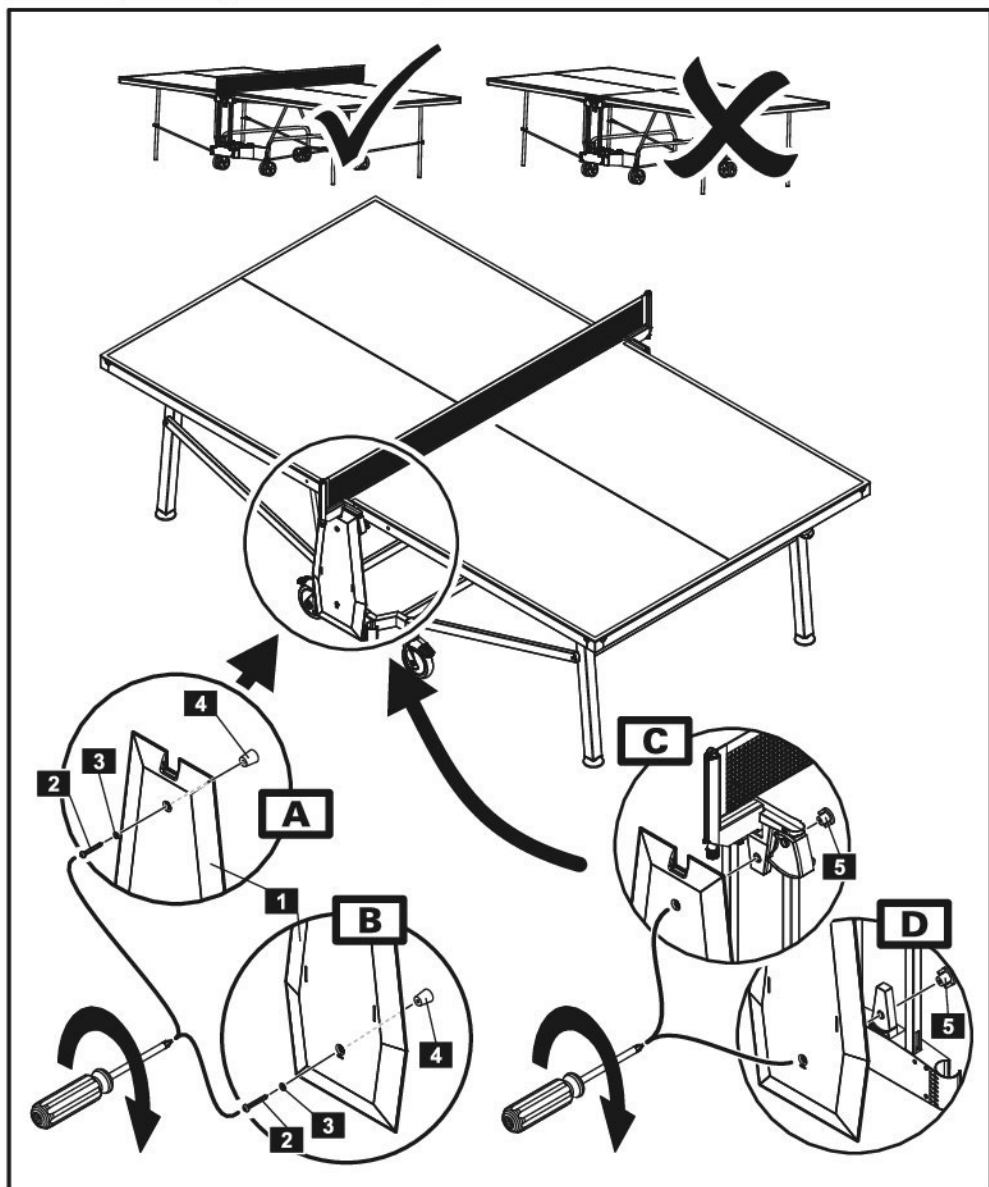
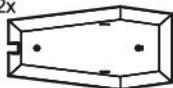
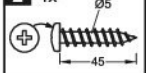

A

865.299.042

2x**1** 2x**2** 4x**3** 4x**4** 4x**5** 4x

B

865.299.042

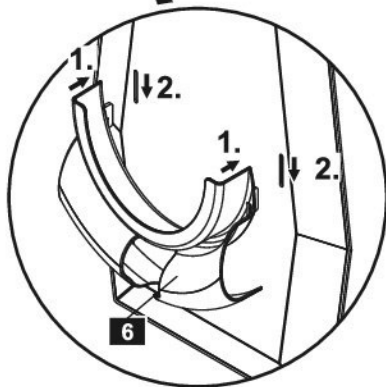
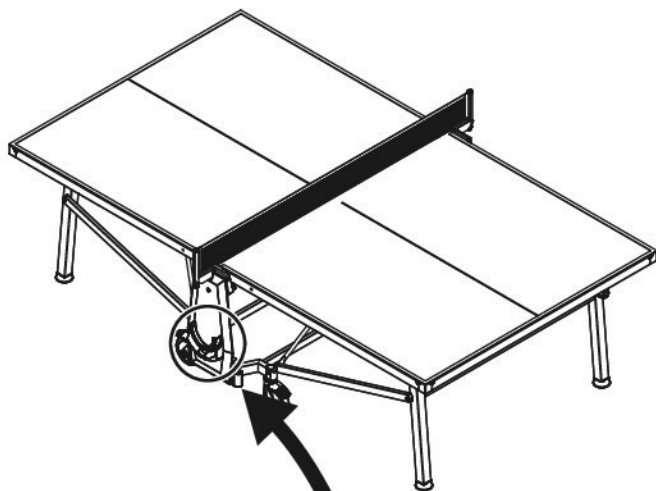
2x**6 2x**